

IN-2210

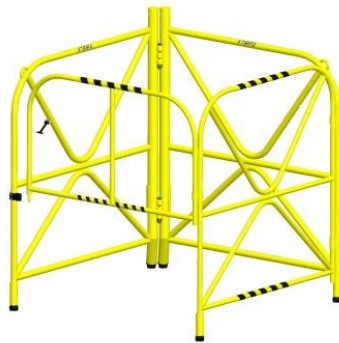

IN-2108



A2108-18
Obligatoire
Mandatory

OPTION



A2108-18
Optionel
Optional

IN-2210



IN-2003



IN-2005



IN-2013



IN-2067



IN-2105

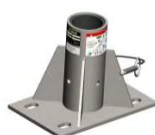

IN-2106

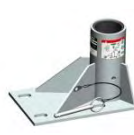

IN-2107



IN-2117



IN-2124



IN-2131



IN-2133



IN-2137



IN-2311



IN-2327



IN-2329





OPTION

IN-2044



IN-2045



IN-2109



IN-2210



IN-2003



IN-2118

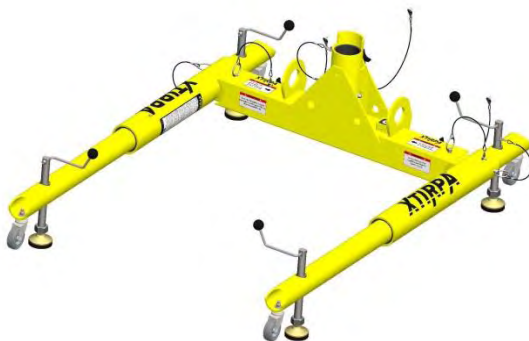

SYSTÈME POTENCE EXTENSIBLE
762mm – 1219mm (30" - 48")
XTIRPA POUR EPI

IN-8005

XTIRPA \square 762mm-1219mm (30" to 48")
Extendable Fall Protection Retrieval
Davit Arm for PPE

IN-2237



IN-2240



IN-2313



IN-2426



IN-2238



IN-2253



IN-2254

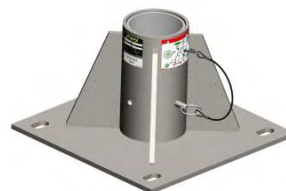

IN-2516



SYSTÈME POTENCE EXTENSIBLE
762mm – 1219mm (30" - 48")
XTIRPA POUR EPI

IN-8005

XTIRPA ☐ 762mm-1219mm (30" to 48")
Extendable Fall Protection Retrieval
Davit Arm for PPE



OPTION

A2237-06



A2237-17



SYSTÈME POTENCE EXTENSIBLE
1524mm – 2439mm (60" - 96")
XTIRPA POUR EPI

IN-8006

XTIRPA ☐ 1524mm-2439mm (60" to 96")
Extendable FallProtection Retrieval
Davit Arm System for PPE

IN-2197



IN-2199



IN-2414



IN-2470



IN-2201



IN-2200



IN-2420



IN-2210



IN-2003



IN-2126



IN-2204



A2126-21



IN-2210



IN-2003



IN-2126



IN-2204



IN-2348



OPTION

A2126-07



A2126-09



A2348-05



A2348-08



IN-8007

IN-2210



IN-2003



IN-2126



IN-2204

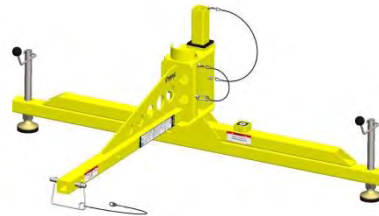

OPTION

A2126-07



A2126-09



A2126-10



A2126-14

A2126-33



A2126-50

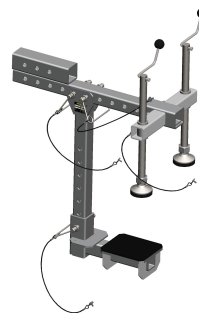

European Vehicle CH1 version



IN-2210



IN-2003



IN-2126

CH1



IN-2204



OPTION

A2126-69

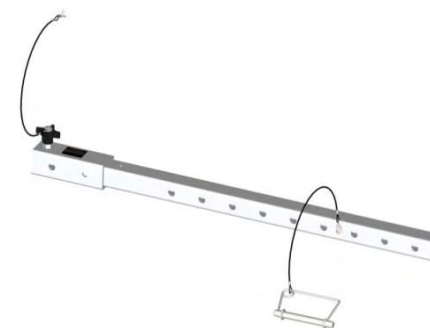

A2126-09



IN-2210



IN-2003



IN-2126



IN-2204



A2126-38



A2305-07



IN-2337



IN-2338



IN-2127



IN-2256



IN-2274



OPTION

IN-2241



IN-2242

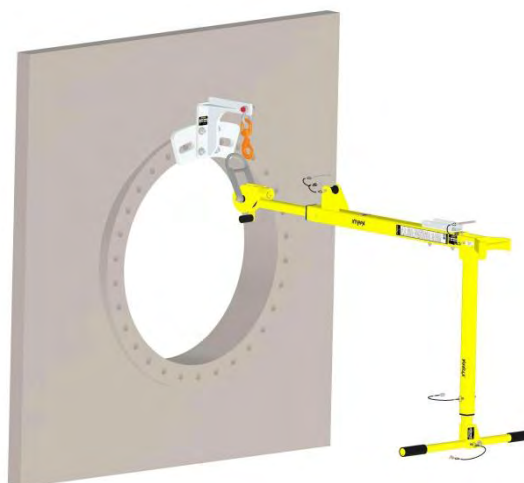

IN-2210



IN-2003



IN-2008

IN-2075

IN-2125

IN-2168

IN-2251



IN-2021

IN-2129

IN-2315



IN-2482



IN-2167

IN-2180

IN-2217

IN-2218

IN-2219

IN-2220

IN-2221

IN-2222

IN-2223

IN-2224

IN-2287

IN-2306

IN-2379

IN-2476



SYSTÈME GRAND GARDE-CORPS PORTATIF
AVEC MÂT INTÉGRÉ 1067 mm (42") XTIRPA™ **IN-8011**

XTIRPA™ 1067mm (42") LARGE PORTABLE
MANHOLE GUARD SYSTEM FOR PPE

IN-2210



IN-2324

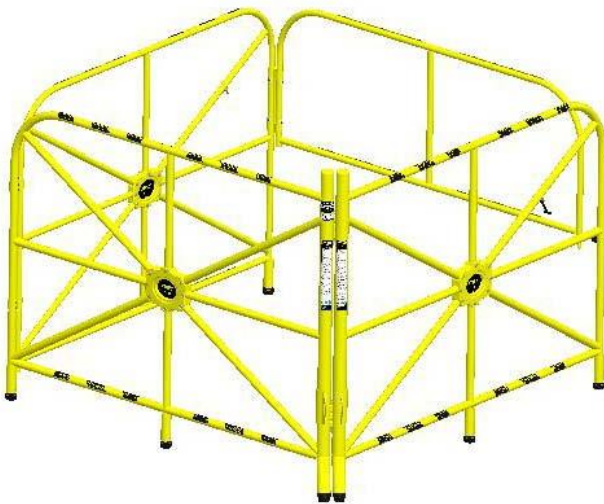

OPTION

A2108-18



A2108-20



A2108-18
Obligatoire
Mandatory



A2108-18
Optionel
Optional

IN-8012

IN-2237



IN-2240



IN-2313



IN-2426



IN-2305



A2305-12



European Vehicle CH2 config.

IN-2237



IN-2240



IN-2426



IN-2305



CH2

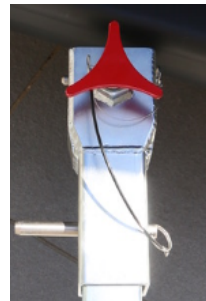

A2305-16



A2305-25



A2305-55



IN-2237



IN-2240



IN-2313



IN-2426



IN-2305



A2305-40



A2305-07



IN-2104



IN-2102 A2102-03

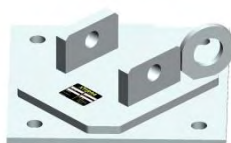

IN-2363



IN-2395



IN-2008

IN-2075

IN-2125

IN-2168

IN-2251



IN-2021

IN-2129

IN-2315



IN-2167

IN-2180

IN-2217

IN-2218

IN-2219

IN-2220

IN-2221

IN-2222

IN-2223

IN-2224

IN-2287

IN-2306

IN-2379

IN-2476

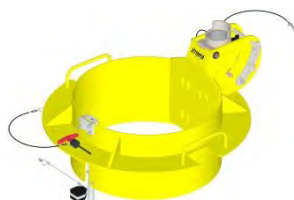

IN-2475

IN-2486

IN-2487

IN-2490

IN-2492

IN-2496

IN-2497

IN-2498

IN-2499

IN-2500



A2395-06



A2395-12

Système Potence Extensible
762mm - 1219mm (30" - 48")
adaptateur amovible Xtirpa pour EPI

IN-8015

Expandable davit arm system
762 mm - 1219 mm (30" - 48")
Xtirpa removable adaptor for PPE

IN-2237



OPTION

A2237-06



IN-2240



IN-2313



IN-2426



IN-2380

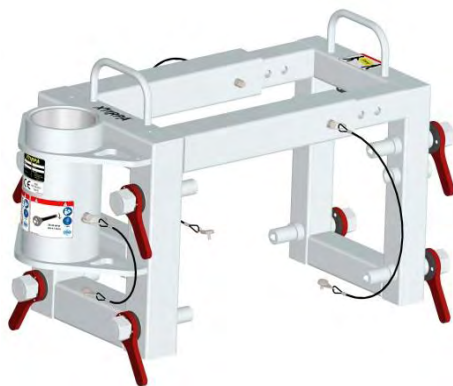

IN-2395



OPTION

A2395-07

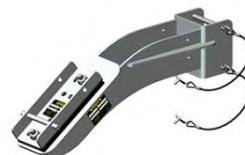

A2395-06



A2395-12



IN-2005



IN-2013



IN-2105



Système mât-potence 24" (610mm),
adaptateur amovible XTIRPA™ pour EPI

IN-8018

XTIRPA™ 24" (610mm) Mast Davit Arm
System with Shoring System

OPTION

A2395-07

IN-2483



IN-2482

